

Product Range

...made by

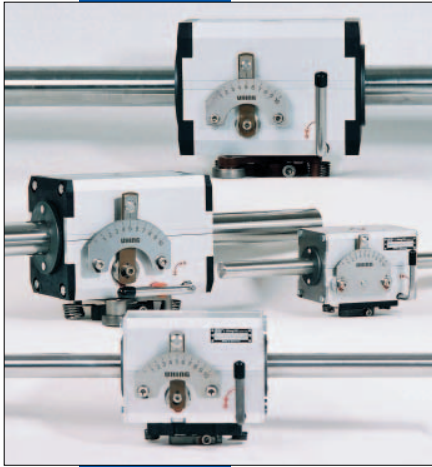



Joachim Uhing KG GmbH & Co. has been successful since 1943.

For production, state-of-the-art multi-axis CNC workstations, for construction and development, high-performance CAD systems are used.

In this context, simulation and calculation programs exclusively developed for Uhing are being used. Regular training of employees and agents warrants Uhing's sales and consulting competency, provided by the headquarters or the agencies for the benefit of the customer.

Due to the high share of exports (approx. 60% of the turnover), a worldwide net of agencies had to be established, offering our customers reliable and competent after-sales service.

If there are any question please contact us.

You can download all catalogues and brochures we show in this Product Range in PDF format from our website:

www.uhing.com.

Information quick and easy?

The Uhing Internet offers many possibilities:

- News
- DXF-formats for downloads and usage in your own constructions
- Catalogue-downloads of all Uhing-products (PDF-format)
- Trade fairs
- Adresses of national and international agencies

Contents

	page
Winding-Systems	3 / 4
Rolling Ring Drive RG, Guide System GS, Non Contact Flange Detecting System FA, Electronic Winding System EWS	
Linear Drive Systems	5
Rolling Ring Drive RG, Linear Drive Nut RS, Timing Belt Drive AZ	
Clamping Systems	6
U-Clip, easylock®	
Engineering	7

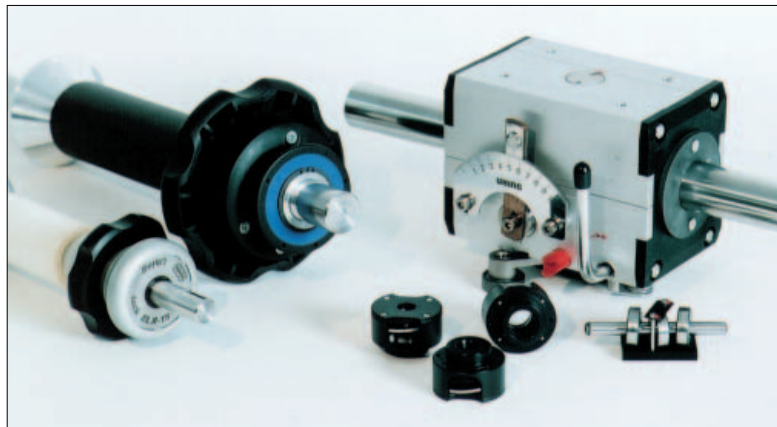

Rolling Ring Drives RG, RGK and KI Features

These drives are mechanical friction drives which convert the constant rotation of a plain shaft in a single direction into two-way reciprocating motion.

They operate on the principle of pivotable ball bearing based Rolling Rings, the specially crowned running surfaces of which are pressed against a shaft. By addressing them to the shaft at an offset angle (pitch) they operate like nuts on a threaded bar, however, because of their ability to swivel, they have alternating left-hand and right-hand pitch (providing reciprocating motion). By varying the pitch angle, the speed of travel can be set at finely stepped increments (with different speeds in the two directions of travel if required) or can be set at zero (standstill).

Reversal is effected via a reversal mechanism, which is connected to the Rolling Rings and which makes contact with adjustable endstops.

Attachment

All functions (reversal, width of stroke, speed and free-movement) can be remotely controlled.

Precise repeatability of movement sequences, including different characteristics in the two directions of travel, possible via cam follower control.

Accommodation of heavy loads and high forces when used in conjunction with additional load carrier.

Standstill on rotating shaft possible with a

high degree of repeat accuracy (external impulse restart). Suitability for two-way shaft rotation.

Pneumatic or electromagnetic reversal.

In addition to our standard range, we can supply you with tailor-made solutions to your specific problems and requirements.

Application areas

- Winding

**For detailed information:
catalogue RG**

Your benefit

- automatic reciprocating motion with constant direction of shaft rotation
- side thrust up to 3600 N
- width of stroke up to 5m
- speed up to 4.2m/sec.
- suitable for horizontal and vertical application
- variable linear output speed from constant shaft input speed
- rapid or speeded down reversal
- high reversal position dynamics
- can be disengaged on the shaft
- good sealing possibilities (plain shaft)
- high efficiency
- low operating costs
- high corrosion protection



Type RG



Type RGK

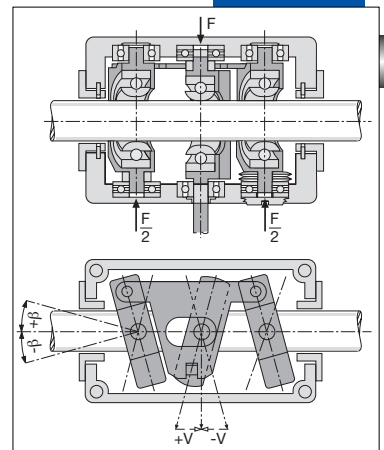

Guide System GS Features

The Uhing Guide System GS transfers the movement of the traverse to the guide roller and the material to be wound. It can be universally adapted to the winding tasks using additional modules.

Application areas

- winding

**For detailed information:
catalogue GS**

Your benefit

- modular design for easy adaption to the winding task
- continuously adjustable
- high rigidity
- adapter for assembly on Uhing Rolling Ring Drives KI, RG15, RG20, RG22 and RG30
- made entirely of stainless steel
- versatile attachment
- options for guide rollers
- suited for all traversing systems



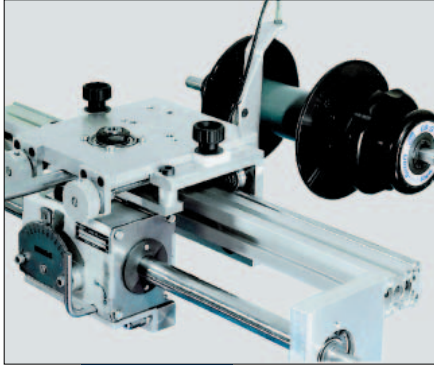

Non Contact Flange Detecting System FA

Features

A light barrier detects the inner sides of the coil flanges and trips the reversal of the traversing unit.

When the speed of the traversing shaft decreases proportional to the filling rate of the coil, the length of travel of the traverse is reduced as the reversal time remains constant. To compensate this stroke reduction, a PLC is available.

Attachment

- Uhing Rolling Ring traverse with pneumatic reversal mechanism
- Load carrier for accommodating sensors and material guide systems
- Light barrier, with adjustable lead and telescoping swivel arm
- Relay controller
- Option: PLC for controlling the reversal time and system for recording the shaft speed

Power requirements

Power supply: 85 - 264 VA.C.
 47 - 63 Hz
 Compressed air: 4 bar

**For detailed information:
 manual FA**

Your benefit

- no readjusting of reversal points after coil change
- no readjusting during winding
- easy to connect
- low price

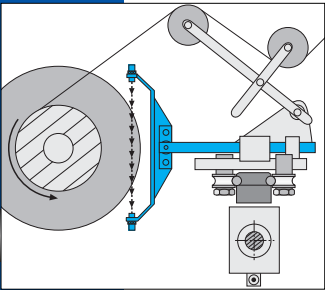

Electronic winding system EWS

Features

Every winding machine features a winding drive, a receptacle for the winding core, a traversing system and necessary control systems.

The traversing system is mainly responsible for the winding pattern, i.e. the winding core structure. However, the basic conditions must be met in case of high demands on the winding pattern. The traversing unit, for example, cannot compensate the negative effects of damaged and deformed coil cores or twisted and bent material. The Uhing-EWS, however, can calculate the optimum pitch from the core shape and size, the material size, the number of layers and the desired material gap.

Various measures are required to attain an optimum winding pattern as winding can be performed on straight or tapered flanges, and even without flange. Round and ribbon-type materials require different handling as well. Uhing-EWS provides a suitable solution for all these requirements.

A material concentration or reduction must be explicitly generated by accelerating or decelerating the traversing system in the critical winding core flange areas. Brief stops are also possible. Tapered winding core ends can be attained by continuously increasing or decreasing the stroke.

Attachment

- winding

**For detailed information:
 manual EWS**



Your benefit

- 130 program slots
- mini terminal or controller using a RS232-/RS485 interface
- German/English user interface
- many specified parameters are possible
- easy installation
- automated reference point travel



Rolling Ring Drive RG

Features

The drive converts the constant rotation of a plain shaft into a twoway reciprocating motion and is also used in the general linear motion area.

Application areas

- Surface treatment / Converting
- Measuring and testing
- Materials handling / Packaging
- Tyre manufacture
- Feeds / Positioning drives
- Power amplifiers (servo functions)
- Drives for synchronous cutting machines
- Sequential drives / Special machines

For detailed information:
catalogue RG



Linear Drive Nut RS

Features

Uhing Linear Drive Nuts are non-positive drives which convert the rotation of a plain shaft into linear motion.

In contrast to Rolling Ring Drives, the Rolling Rings are not arranged to swivel but are fitted at a fixed angle of pitch, the speed being varied by varying the speed of the shaft. The change of direction is achieved by reversing the direction of rotation of the shaft.

Backlash-free, low noise, rolling-friction giving high-efficiency, combined drive and carrier, release mechanism enables unit to be manually positioned on the shaft, compact design, small space requirement, safe as it will slip when overloaded, thrust can be multiplied by ganging-up units, available with a variety of pitches, left- and right-hand pitch on the same shaft possible, good sealing possibilities e.g. for use in dusty, dirty or humid environments. Wherever linear motion is required, the Uhing Linear Drive Nut is a modern alternative to hydraulics and pneumatics, chain drives and lead screws.

Application areas

- Co-ordinate measuring machines
- Inspection technology
- Materials handling
- Conveyor systems
- Engine controls

For detailed information: catalogue RS



Your benefit

- converts rotary motion into linear motion
- backlash free
- low noise
- low maintenance
- compact
- good sealing possibilities (plain shaft)
- drive can be disengaged on the shaft
- low operating costs
- comprehensive range of sizes
- resistant against vibration
- high corrosion protection

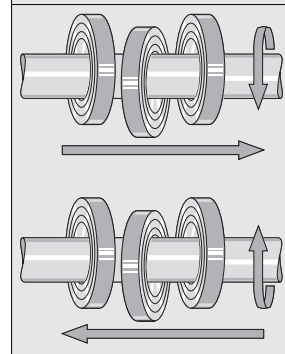

Timing Belt Drive AZ

Features

The basis of the Uhing Z -Drive is a bending and torsion resistant rigid aluminium profile.

A number of T-slots in the carrier section offer variable extension possibilities and simplify assembly. Slide connection blocks can be easily inserted. The transmission of power from the drive belt to the load carrier is via belt fastener fitted to the carrier.

Uhing-Z-Drives are characterized by the use of high grade materials including corrosion resistant hardened guide rails and robust timing belts which retain their shape. They are precise, positionally exact, reach high acceleration rates and speeds and are built for long life.

Application area:

- drive technologies

For detailed information:
catalogue AZ

Your benefit

- easy to fit
- precise guiding
- high linear speeds and rates of acceleration
- comprehensive range of types and accessories



UHING Clamping Systems



U-Clip Shaft collar for smooth shafts/tubes

Features

As easylock® U-Clip is using a clamping ring, too which is off-set to the shaft and therefore clamping forces are provided. Like a bushing the U-Clip is pushed forward against the to be fixed component and it automatically locks into position. To release, just pull the clamping ring towards the user.

Application areas:

- Positioning on rotating and non-rotating shafts, e.g. wind-up and pay-off
- Tube to shaft (or tube) connection, e.g. tripods
- Fixing components on shafts, e.g. dumb-bell weights
- Quick adjustment for material guiding, e.g. packaging machines

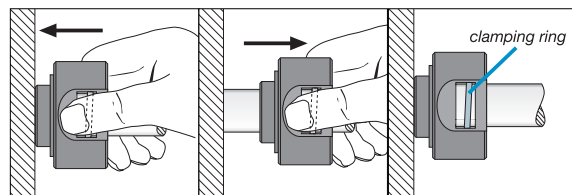

more information: catalogue UC

Your benefit

- usage on hardened and soft surfaces
- self locking
- one hand operation
- symmetrical design
- high self locking force compared to ball systems with inclined level
- corrosion protected
- resistant against vibration



easylock® Fast Action Clamping System EL

Features

The Uhing-easylock® System is characterized by ease of handling and its clamping/tensioning function. The result is rapid roll changing combined with high but sensitively applied retaining pressures for spools and rolls of flexible width and with varying core diameters in a modular system suitable for a variety of applications. Its main component parts are a fixed pintle and a clamping section comprising a tensioning unit and an interchangeable pintle point.

Its function relates to a clamping ring which is located in the tensioning unit and which is brought into pressure contact with the shaft. The greater the tensioning force, the greater is the clamping effect of the ring.

The spool or roll is retained and fixed by pushing the tensioning unit up against it and turning the tensioning wheel until the required clamping force has been achieved.

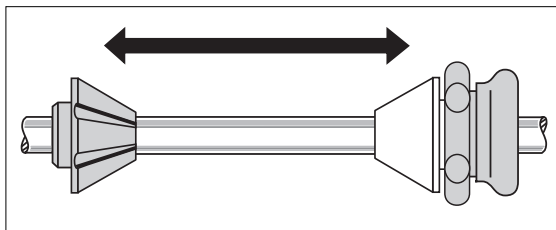

To release, the clamping force is reduced via the tensioning wheel and the clamping pintle is pulled off the shaft. Also suitable for driven shafts.

Application areas:

- winding
- spools / supply rolls
- packing machines
- static applications

For detailed information: catalogue EL

Your benefit

- shortest possible roll change-over times
- high but sensitively controlled clamping pressure
- single handed operation
- extremely flexible in operation
- plain shaft
- maintenance free
- safe in case of emergency stop
- resistant against vibration

The Joachim Uhing KG GmbH & Co. has a long lasting experience in development and handling of exacting engineering projects.

Some 10% of our employees are working in the R&D departments. To handle complex tasks, they have access to state-of-the-art CAD systems, a company-wide computer network and specially developed calculation programs.

We have particularly extensive experience in the sectors of winding technology and periphery, and general drive technology. Apart from design, development and authoring of manufacturing documentation we also offer the supply of partial or complete supply of special-purpose plants.

UHING Analysis

We determine the status quo on site, discuss possibilities in co-operation with all persons concerned, and define the objectives of the plant in question.

Uhing Conception

We turn the information gathered during analysis, paired with customer suggestions and in line with existing technical possibilities and qualifications, into a project concept, present it and synchronize with the customer.

UHING Development

Using cutting edge CAD systems we design machine components, subsystems and special-purpose devices down to the component level and build prototypes if required.

Due to long years of experience Uhing is capable of precise and in-time production.

UHING Production

Production of products as single element or in an overall package. Depending on the requirements, we also employ 2nd tier manufacturers. The next step are test runs.

UHING Installation

Uhing full-service quality. Uhing employees install the special-purpose machines, perform the test runs and accompany their implementation until production.

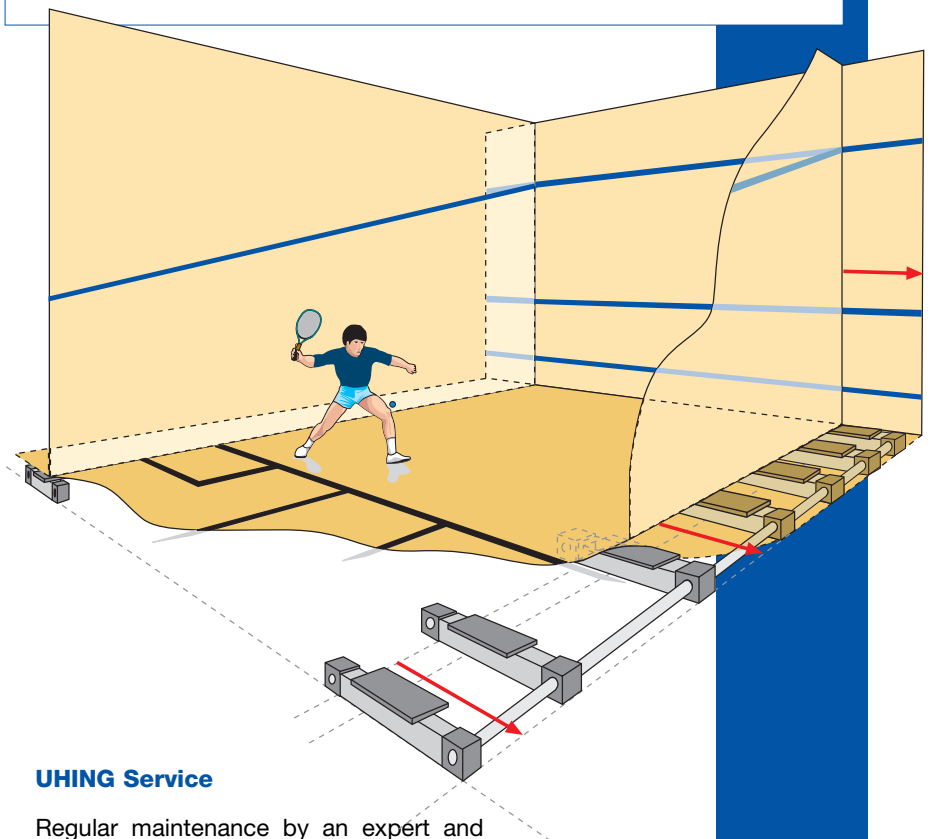
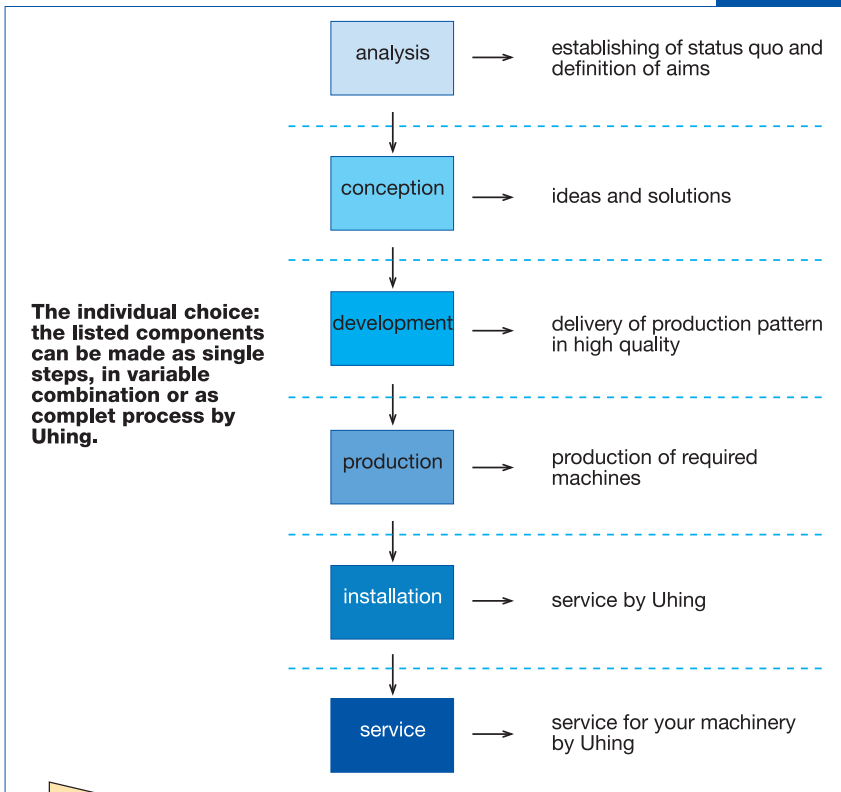

UHING Service

Regular maintenance by an expert and genuine spare parts ensure trouble free system operation. Upon conclusion of a maintenance contract, we define the maintenance parameters for your machine (time, scope).

Uhing

worldwide Service

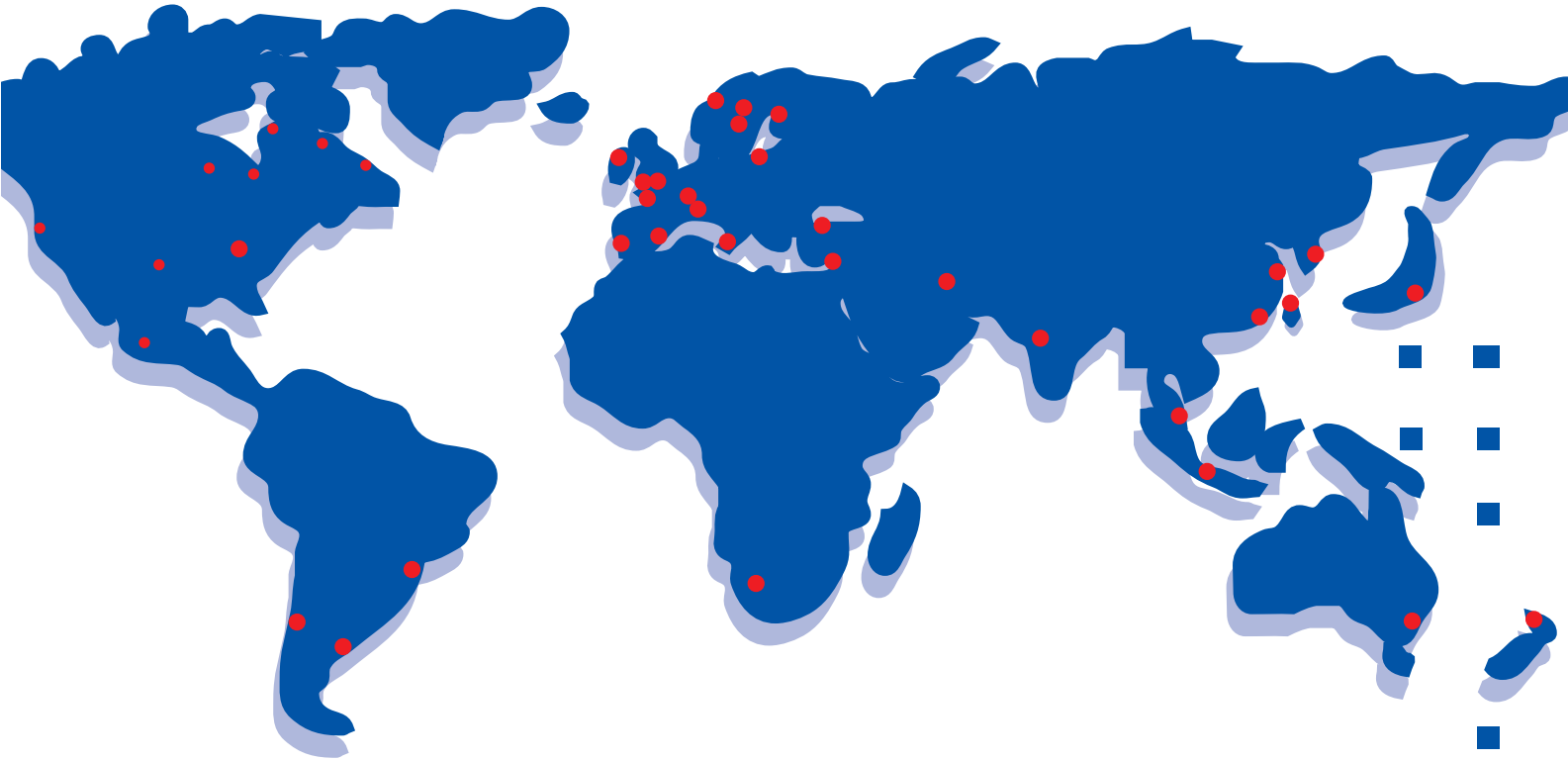

**Die Adressen unserer
Fachvertretungen finden
Sie im Internet:**

**The addresses of our agencies
are available in the internet:**

<http://www.uhing.com>

Joachim Uhing KG
GmbH & Co.
Kieler Strasse 23
24247 Mielkendorf
Telefon +49 (0) 4347 - 906-0
Telefax +49 (0) 4347 - 906-40
e-mail: sales@uhing.com
Internet: www.uhing.com
Germany

